



# TRAK™ 72 WITH LIGHT

## POWER & EFFICIENCY

---

**Input Power Options:** 120v

**Current at Max Speed:** 1.16 Amps

**Power:** 0.13 hp

**Maximum Speed:** 8 mph

**Maximum Affected Area:** 24 ft. diameter / 576 sq. ft.

**Light Kit:** 30W LED, 900 Lumens, LM/W 30

## MODELS

76012

76013

76014

## DIMENSIONS & WEIGHT

---

**Fan Diameter:** 72 inches

**Fan Weight:** 48 lbs

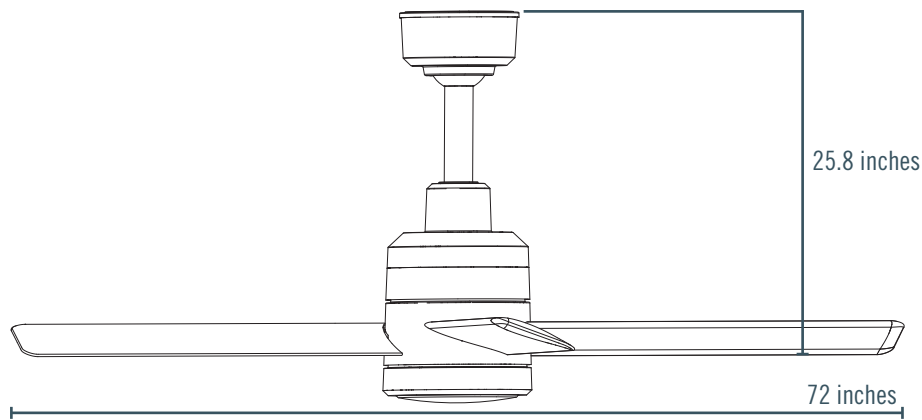

## MOUNTING & SAFETY

---

**Mounting Options:** Standard / Angles

**Downrod:** 11" Down Rod

**Safety Features:**

## INCLUDED IN THE BOX

---

**included:** Wall Control, 11" Down Rod

**Optional:** Handheld Control

Down Rod Sizes: 24", 36", 48", 60", 72"

## WARRANTY & CERTIFICATIONS

---

**Certifications:** ETL/Intertek-certified to ANSI/UL 506 and CSA C22.2 No. 113 in North America

Indoor/Outdoor/Damp Rating: IP44

**Warranty<sup>1</sup>:** 3-Year Warranty on Parts